

## SFP-LPT5 SFP28 LOOPBACK Active Electrical Loopback Module

### Features

- Hot-pluggable SFP28 form factor
- 1 channels Electrical Loopback Module
- Supports 25Gbps data rate
- Low power dissipation <1W
- RoHS compliant (lead-free)
- Single 3.3V power supply
- SFP28 MSA compliant
- Case temperature range of 0°C to 70°C

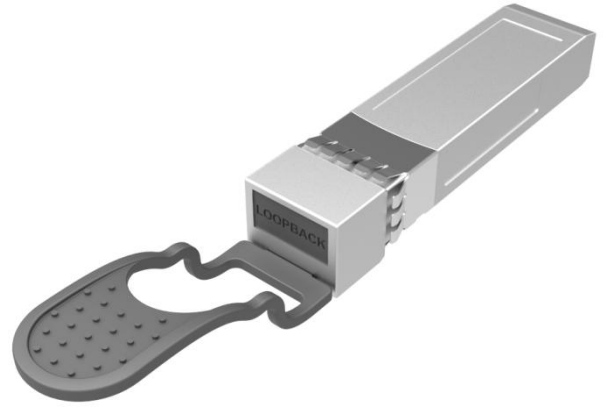

### Applications

- 25G Ethernet
- Support 10G by CDR bypass

### Description

SFP-LPT5 SFP28 active electrical loopback is used for testing 25G SFP28 transceiver ports in board level test. By substituting for a full-featured SFP28 transceiver, the electrical loopback provides a cost effective low loss method for SFP28 port testing.

The SFP-LPT5 is packaged in a standard MSA housing compatible with all SFP28 ports. Transmit data from the host is electrically routed (internal to the loopback module) to the receive data outputs and back to the host. Since the loopback module does not contain laser diodes, photodiodes, laser driver or transimpedance amplifier chips, etc., it provides an economical way to exercise SFP28 ports during R&D validation, production testing and field testing.

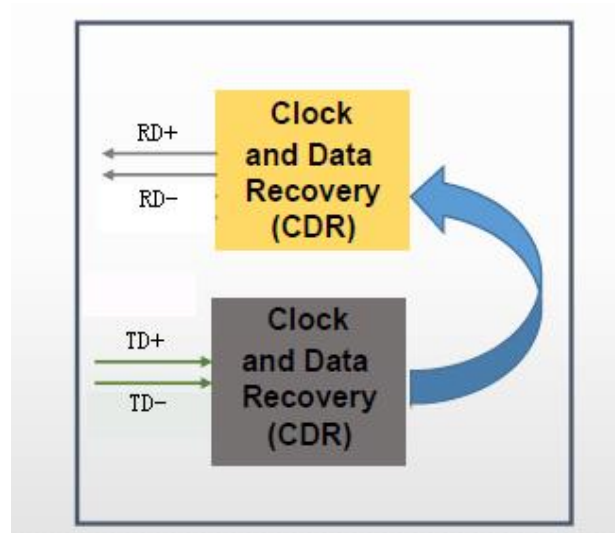

**Figure 1. Module Block Diagram**

**Absolute Maximum Ratings**

Parameter	Symbol	Min	Max	Unit
Supply Voltage	$V_{cc}$	-0.3	3.6	V
Input Voltage	$V_{in}$	-0.3	$V_{cc}+0.3$	V
Storage Temperature	$T_s$	-40	85	°C
Case Operating Temperature	$T_c$	0	70	°C
Humidity (non-condensing)	Rh	5	95	%

**Recommended Operating Conditions**

Parameter	Symbol	Min	Typical	Max	Unit
Supply Voltage	$V_{cc}$	3.13	3.3	3.47	V
Operating Case Temperature	$T_c$	0		70	°C
Data Rate Per Lane	fd		25.78125		Gb/s
Humidity	Rh	5		85	%
Power Dissipation	$P_m$			1	W

### Electrical Specifications

Parameter	Symbol	Min	Typical	Max	Unit
Differential Input Impedance	Z <sub>in</sub>	90	100	110	ohm
Differential Output Impedance	Z <sub>out</sub>	90	100	110	ohm
Differential Input Voltage Amplitude	ΔV <sub>in</sub>	300		900	mVpp
Differential Output Voltage Amplitude	ΔV <sub>out</sub>	300		800	mVpp
Bit Error Rate	BER			E-12	
Input Logic Level High	V <sub>IH</sub>	2.0		V <sub>cc</sub>	V
Input Logic Level Low	V <sub>IL</sub>	0		0.8	V
Output Logic Level High	V <sub>OH</sub>	V <sub>cc</sub> -0.5		V <sub>cc</sub>	V
Output Logic Level Low	V <sub>OL</sub>	0		0.4	V

### Pin Definitions

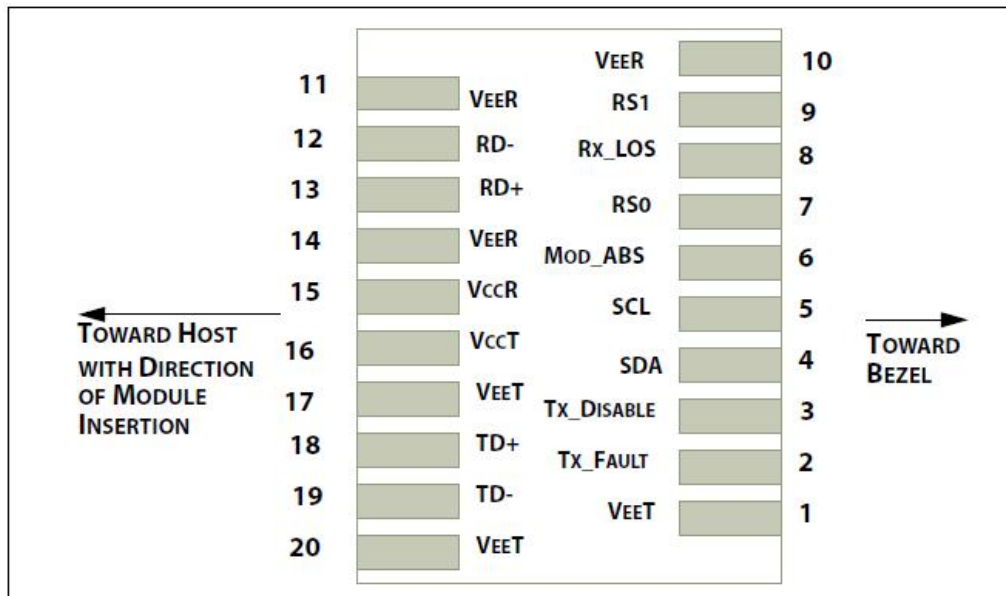

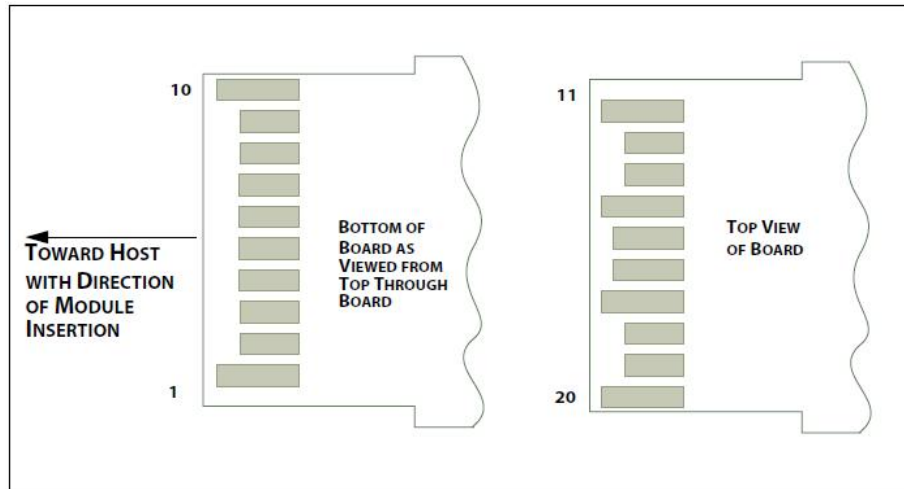

**Figure 2. Electrical Pin-out Details**

**Pin Descriptions**

PIN	Logic	Symbol	Name / Description	Note
1		VeeT	Module Transmitter Ground	1
2	LVTTL-O	TX_Fault	Module Transmitter Fault	2
3	LVTTL-I	TX_Dis	Transmitter Disable; Turns off transmitter laser output	
4	LVTTL-I/O	SDA	2-Wire Serial Interface Data Line	2
5	LVTTL-I	SCL	2-Wire Serial Interface Clock	2
6		MOD_ABS	Module Definition, Grounded in the module	
7	LVTTL-I	RS0	Receiver Rate Select	
8	LVTTL-O	RX_LOS	Receiver Loss of Signal Indication Active LOW	
9	LVTTL-I	RS1	Transmitter Rate Select (not used)	
10		VeeR	Module Receiver Ground	1
11		VeeR	Module Receiver Ground	1
12	CML-O	RD-	Receiver Inverted Data Output	
13	CML-O	RD+	Receiver Data Output	
14		VeeR	Module Receiver Ground	1
15		VccR	Module Receiver 3.3 V Supply	
16		VccT	Module Receiver 3.3 V Supply	
17		VeeT	Module Transmitter Ground	1

18	CML-I	TD+	Transmitter Non-Inverted Data Input	
19	CML-I	TD-	Transmitter Inverted Data Input	
20		VeeT	Module Transmitter Ground	1

**Notes:**

1. Module ground pins GND are isolated from the module case.
2. Shall be pulled up with 4.7K-10Kohms to a voltage between 3.15V and 3.45V on the host board.

**Recommended Interface Circuit**

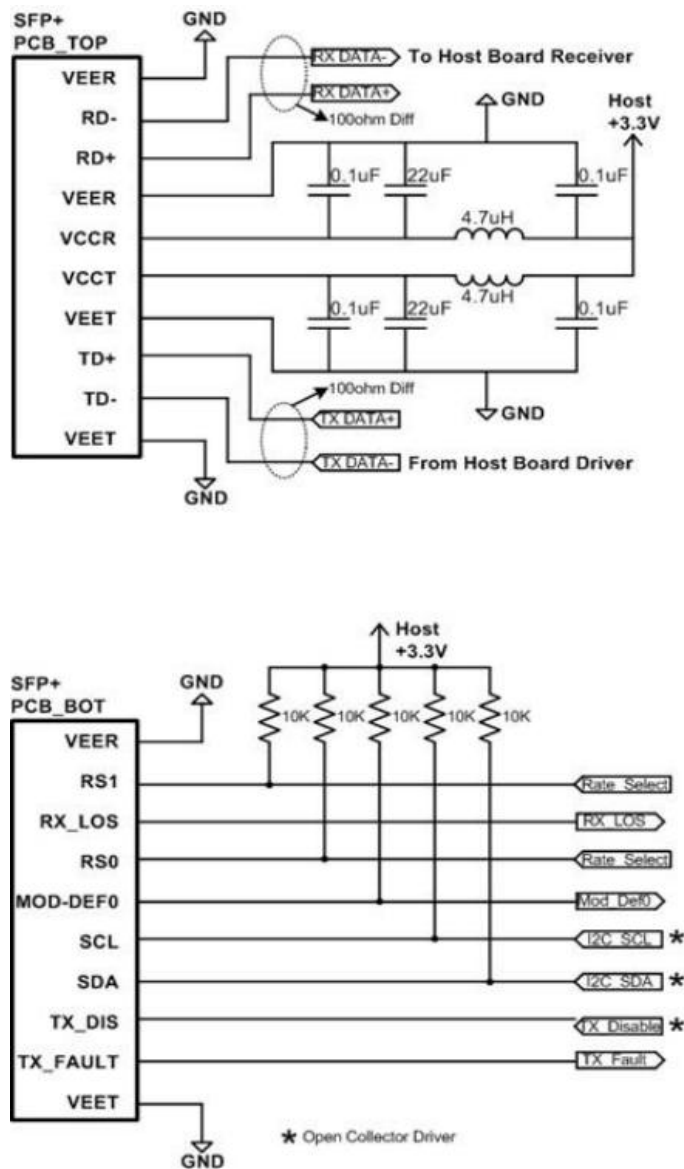
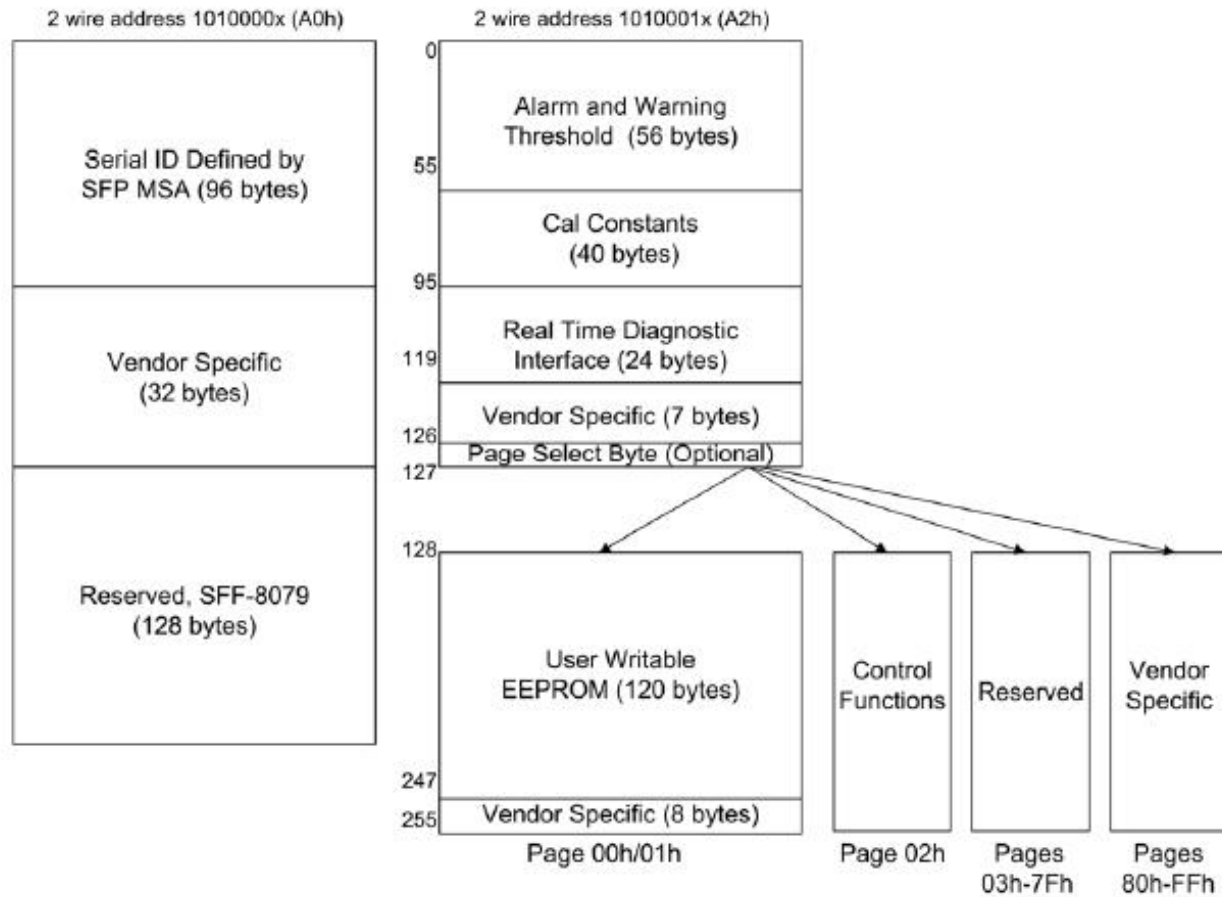

**Figure 3. Host Board Power Supply Filtering**

## Memory Organization

The transceivers provide serial ID memory contents and diagnostic information about the present operating conditions by the 2-wire serial interface (SCL, SDA). The memory map specific data field defines as following.

### Two-wire Interface Fields



TWO-WIRE INTERFACE FIELDS  
**Figure4. Memory Map**

**Mechanical Dimensions**

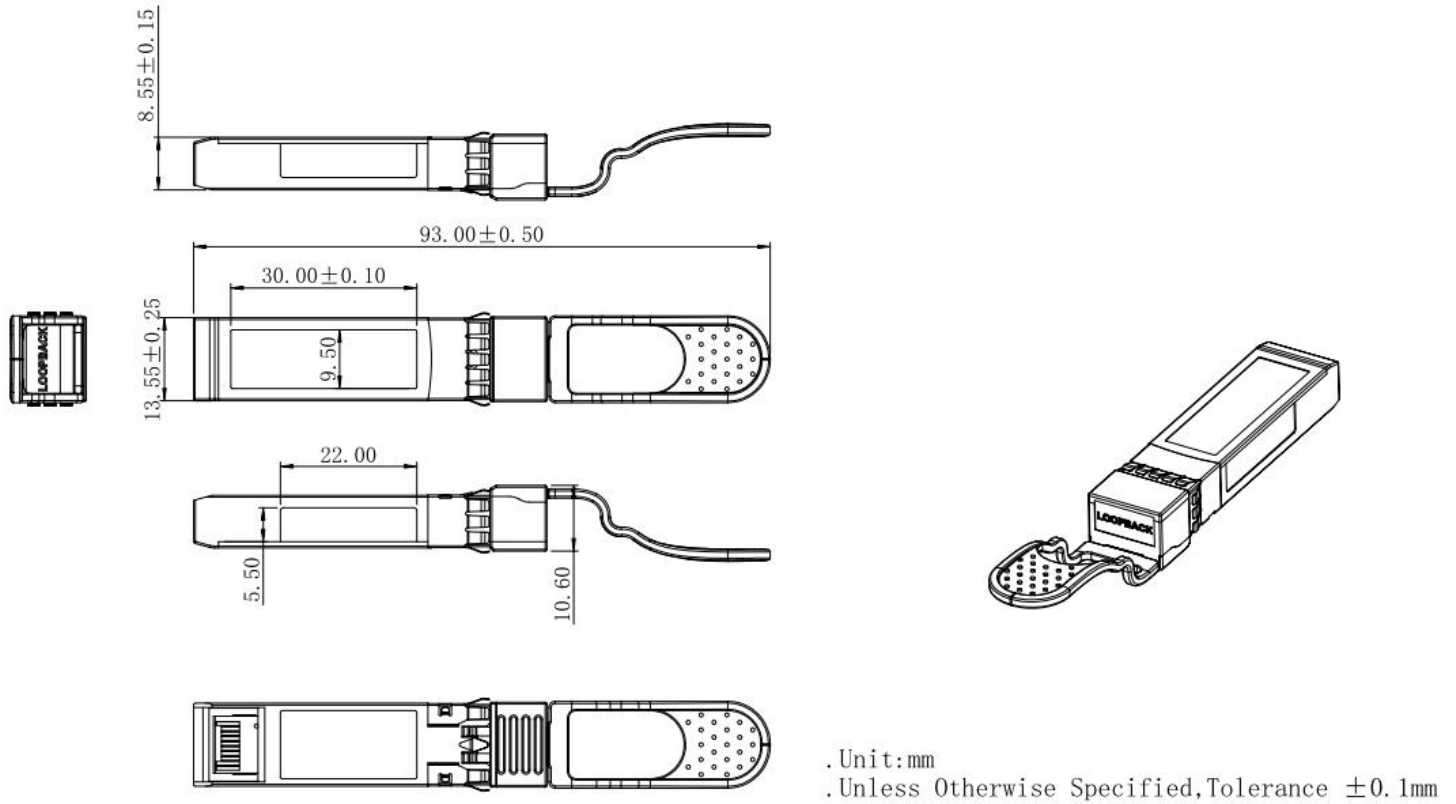

**Figure 5. Mechanical Specifications**

**Ordering information**

Part Number	Product Description
SFP-LPT5	25G SFP28 Active Electrical Loopback

**For More Information**

Tel:+86-755-23301665  
E-mail : [sales@fibertoptech.com](mailto:sales@fibertoptech.com)  
Web: <http://www.fibertopsfp.com>